

RoHS Compliant

REV	ECN No.	DATE	REMARK
A0	NEW	2024.7.1	NEW RELEASE

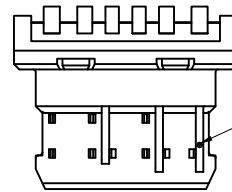
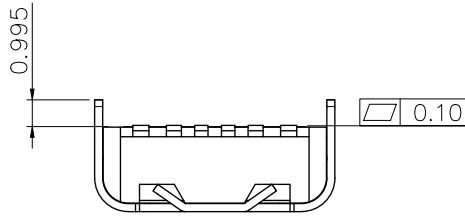

接触区域镀金测点

备注：

1. 材质：

1.1 胶芯：LCP E130I, UL94V-0

1.2 端子：黄铜C2680 镍底30U"MIN

接触区域镀金G/F, 焊接区域镀金G/F

1.3 外壳：SUS201, T=0.30mm 表面镀镍40U"MIN

1.4 中夹片：SUS201

2. 主要特性：

2.1 额定电流：3A

2.2 接触阻抗：40mΩ MAX (初始值)

50mΩ MAX (测试后)

2.3 绝缘阻抗：100MΩ MIN

2.4 耐压测试：100V AC R M S

2.5 整体插入力：5-20N 整体插入力：5-20N (耐久后)

整体拔出力：8-20N 整体拔出力：6-20N (耐久后)

2.6 耐久：10000次

2.7 耐高温：SMT回流焊 (峰值260±5°)，塑胶不能有起泡，

融胶等不良，变色，翘曲变形在公差范围以内。

2.8 产品须做焊锡测试，粘锡面积达到95%以上：

2.9 盐雾测试：24H MIN

3.0 工作温度：-25°C~+80°C

胶芯主体

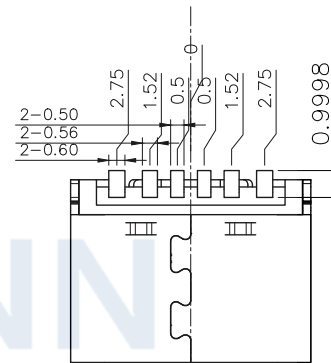

外壳电镀测点

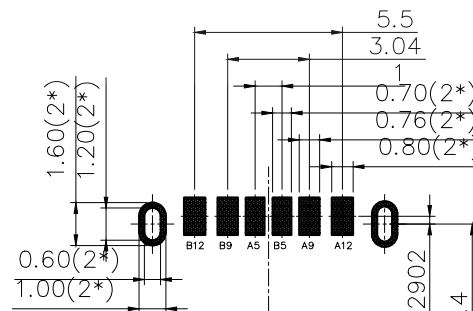
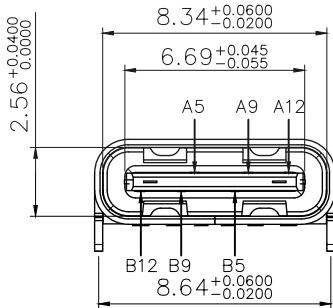
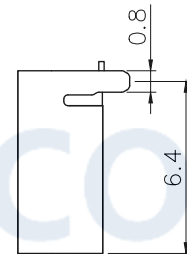
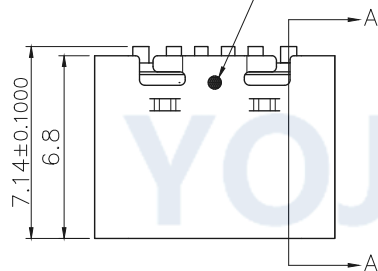

RECOMMENDED P.C.B. LAYOUT
TOLERANCE UNSPECIFIED ±0.05mm

USB TYPE-C PIN ASSIGNMENTS

PIN NUMBER	SIGNAL NAME	PIN NUMBER	SIGNAL NAME
A5	CC1	B12	GND
A9	VBUS	B9	VBUS
A12	GND	B5	CC2

GENERAL TOLERANCES		深圳市跃佳电子有限公司 SHENZHEN YOJACONN ELECTRONICS CO.,LTD.	
x.xxxx	± ---	TITLE	TYPE-C母座 6P 卧式后两脚插CH1.63 长6.8Z3带夹片
x.xxx	± 0.10	DRAWN BY	XGC 2024.5.30 UNIT MM PART NO. CF6R-22DS68Z3-163SN10
x.xx	± 0.25	CHECKED BY	ZKX 2024.5.30 SIZE A4 DWG NO. CF06-009
x.x	± 0.30	APPROVED BY	LLQ 2024.7.1 SCALE PROJECTION SHEET 1 OF 1
ANGULAR	± ---°		